



INITIA 3 FF

N° 1730

CPN456243090

INITIA 3 2.24 FF

Tab 237

Tab 237

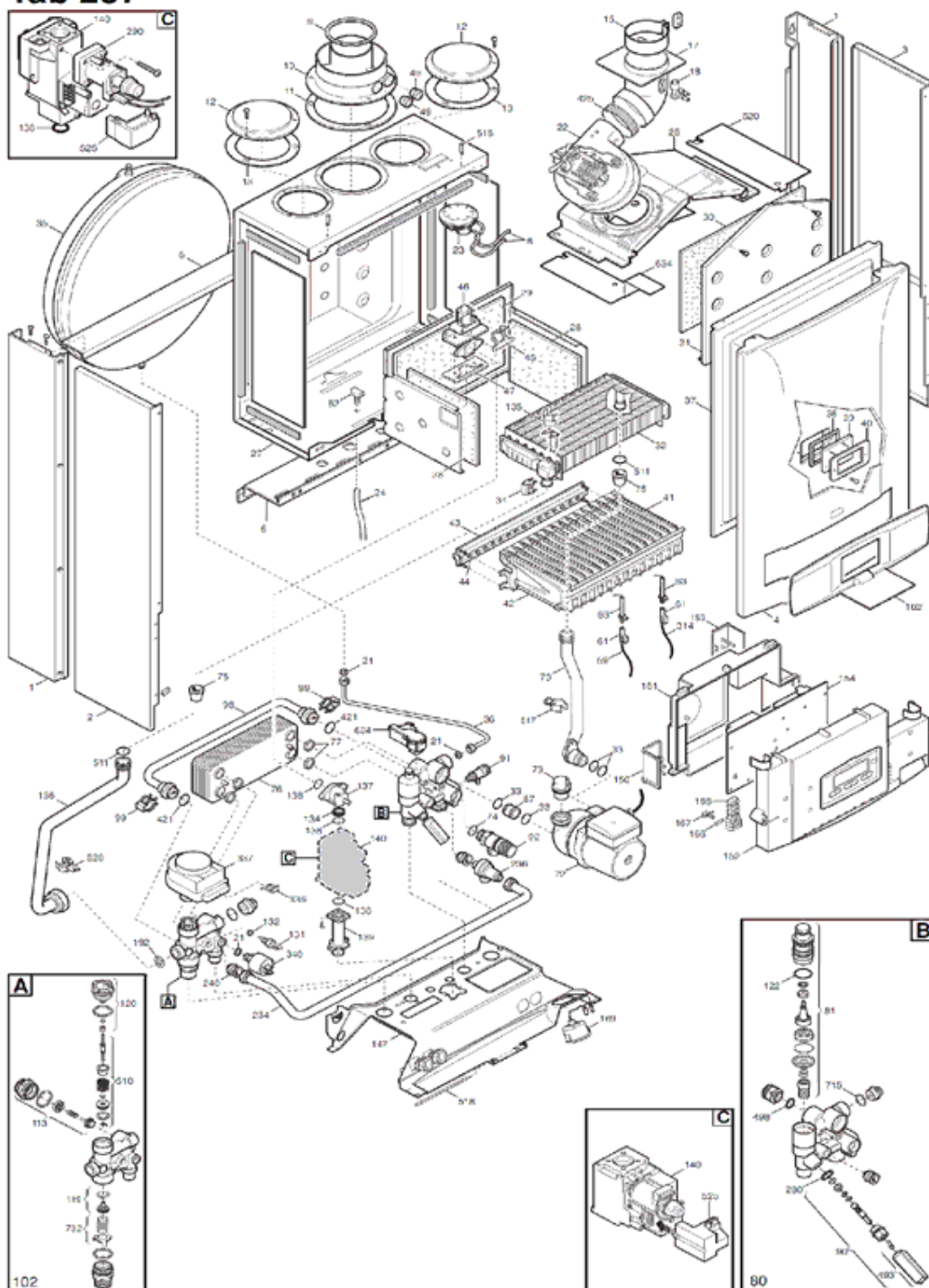

Repère	Référence	Désignation	Quantité
1	SX5683090	MONTANT LATERAL (5683090)	1.000
10	SX5207060	RACCORDEMENT VENTOUSE (5207060)	1.000
102	SX5687140	ENS.VANNE 3 VOIES	1.000
11	SX5407890	JOINT VENTOUSE CAOUTCHOUC (5407890)	1.000
113	SX0617100	GROUPE BY-PASS	1.000
114	SX5403820	JOINT O-RING (x3) (5403820)	1.000
119	SX0605760	CLAPET CHAUFFAGE V3V (605760)	1.000
12	SX5108690	OBTURATEUR (5108690)	1.000
120	SX0600750	BOUCHON V3V CHAUFFAGE	1.000
122	SX5405370	O-RING "FILTRE SANITAIRE" (x3) (5405370)	1.000
13	SX5407400	JOINT OBTURATEUR DECOUPE (x3)	1.000
131	SX8434820	SONDE CTN CH et SN MURALE (8434820)	1.000
132	SX5402830	JOINT SONDE SANITAIRE (X10) (PDM5402830)	1.000
134	SX5214000	DIAPHRAGME GAZ 4,9mm (5214000)	1.000
135	SX9951610	SECURITE DE CHAUFFAGE 105° (9951610)	1.000
136	SX5681010	TUBE DEPART CHAUF/ECHANGEUR (5681010)	1.000
137	SX0610080	TUBE GAZ (610080)	1.000
138	SX5402010	JOINT O-RING (x3) (PDM5402010)	1.000
139	SX5210630	RACCORD ENTREE GAZ ((5210630)	1.000
140	SX5653610	VANNE GAZ SIT (845 SIGMA)	1.000
140	SX5665220	VANNE GAZ HONEYWELL (VK4105M)	1.000
147	SX5680910	TRAVERSE LUNA 3 (5680910)	1.000
15	SX0600530	COLLIER SORTIE EXTRACTEUR (0600530)	1.000
151	SX5412250	COUVERCLE BOITE ELECTRIQUE (5412250)	1.000
152	SX5681340	PANNEAU DE COMMANDE LUNA 3(5681340)	1.000
153	SX5407660	COUVERCLE BRANCHE.ELECTRIQUE (5407660)	1.000
154	SX5687010	CIRCUIT IMPRIME BetP SERIE 3 (5687010)	1.000
162	SX5687380	FACADE TABLEAU BORD INITIA (5687380)	1.000
166	SX8421590	BORNIER DE RACCORDEMENT (PDM8421590)	1.000
167	SX5405340	PORTE-FUSIBLES (x3) (PDM5405340)	1.000
168	SX9950580	FUSIBLES 2A 250V (X10) (9950580)	1.000
169	SX9951650	MANOMETRE AVEC SUPPORT (9951650)	1.000
17	SX5213750	COUDE EVACUATION FUMEEES (5213750)	1.000
18	SX5407050	VENTURI (5407050)	1.000
192	SX5404650	JOINT G3/4" 17x24x2 (X10) #	1.000
2	SX5681390	PANNEAU COTE GAUCHE	1.000
21	SX5402050	JOINT 6,1x11,5x1,5 (X3)	1.000
22	SX5653850	EXTRACTEUR 1V MVL RLG108 (5653850)	1.000
22	SX5628080	EXTRACTEUR 2V 55W 220V	1.000
23	SX0618470	PRESSOSTAT 1,2MB HONEYWELL	1.000
234	SX5687180	TUBE DISCONNECTEUR WATTS LUNA3 (5687180)	1.000
236	SX5658650	DISCONNECTEUR WATTS(jjj005658650)	1.000
24	SX5407930	TUBE SILICONE PRISE LG.150 (5407930)	1.000
240	SX0618480	CLAPET AVEC RACCORD ET O RING (0618480)	1.000
25	SX5681090	HOTTE EVACUATION DES FUMEEES (5681090)	1.000
27	SX5681180	CHAMBRE ETANCHE (5681180)	1.000
28	SX5213190	PANNEAU ISOLANT LATERAL(5213190)	1.000
280	SX5207730	JOINT 14,2X18X1,5 AL-18 (x3) (5207730)	1.000

Repère	Référence	Désignation	Quantité
29	SX5213290	PANNEAU ISOLANT ARRIERE 32KW (5213290)	1.000
290	SX5665230	VANNE GAZ VK 4105 M (5665230)	1.000
3	SX5681380	PANNEAU COTE DROIT	1.000
30	SX5213340	PANNEAU ISOLANT AVANT (5213340)	1.000
31	SX5111840	PANNEAU AVANT CHAMBRE COMBUSTION (5111840)	1.000
314	SX8418870	CABLE ELECTRODE D'IONISATION (x2) (8418870)	1.000
32	SX5692520	ECHANGEUR ENSEMBLE 25KW GIANN	1.000
32	SX5681190	ECHANGEUR H2O/GAS (5681190)	1.000
33	SX5403130	O-RING 22X3 EPDM (x3) (5403130)	1.000
336	SX8380680	RESSORT FIX MOTEUR V3V	1.000
337	SX5647340	MOTEUR V3V ELBI	1.000
34	SX5113650	CLIPS ECHANGEUR PRINCIPAL	1.000
340	SX5663750	PRESSOSTAT CHAUFFAGE (5663750)	1.000
340	SX9951690	PRESSOSTAT CHAUFFAGE (9951690)	1.000
35	SX5625560	VASE D'EXPANSION 8L(PDM5625560)	1.000
36	SX5653290	TUBE VASE D'EXPANSION (5653290)	1.000
37	SX5653710	PANNEAU AVANT CHAMBRE ETANCHE (5653710)	1.000
38	SX5401610	JOINT HUBLLOT (x3) (5401610)	1.000
39	SX5203930	HUBLLOT (5203930)	1.000
4	SX5116810	PANNEAU AVANT INITIA 3 (5116810)	1.000
40	SX5103360	COUVERCLE HUBLLOT (5103360)	1.000
41	SX5653300	BRULEUR 15 BECS (5653300)	1.000
42	SX5604090	ELEMENT BRULEUR (5604090)	1.000
421	SX5408270	O-RING 11,91x2,62 EPDMR	1.000
425	SX5412270	JOINT DE VENTURI (5412270)	1.000
43	SX0606140	NOURRICE PORTE-INJECTEUR 15T.D.1,18 (606140)	1.000
44	SX0608440	KIT INJECTEURS D.1,18 GN (608440)	1.000
44	SX0601520	KIT INJECTEURS D.0,74 BP (601520)	1.000
44	SX5688320	KIT INJECTEURS D.0,74 BP (5688320)	1.000
45	SX5407940	JOINT NOURRICE (x3) (5407940)	1.000
46	SX5657180	RACCORD NOURRICE (5657180)	1.000
47	SX5407810	JOINT NOURRICE/CAISSON (5407810)	1.000
49	SX5207070	BOUCHON RACCORDEMENT VENTOUSE (5207070)	1.000
493	SX0605660	MANETTE ROBINET REMPLISSAGE	1.000
498	SX0400030	JOINT O RING (0400030)	1.000
5	SX5110290	TRAVERSE ARRIERE SUPERIEURE (5110290)	1.000
510	SX0600760	ENS.OBTURATEUR SANITAIRE (600760)	1.000
511	SX5404600	O-RING 17,86X2,62 (X3)	1.000
516	SX5210670	PISTON (5210670)	1.000
517	SX5407840	CLIP FIXATION TUBE (5407840)	1.000
518	SX5112040	CHEVILLE PANNEAU COMMANDE (5112040)	1.000
520	SX5112050	VOLET (5112050)	1.000
525	SX8510910	ALLUMEUR VG HONEYWELL	1.000
528	SX8435360	SONDE ITS (8435360)	1.000
59	SX8419050	CABLE ELECTRODE D'ALLUMAGE (x2) (8419050)	1.000
6	SX5109640	TRAVERSE ARRIERE INFERIEURE (5109640)	1.000
600	SX5112530	RESSORT FIXATION DISCONNECTEUR (5112530)	1.000
61	SX5407830	PROTECTION ELECTRODE (x3) (5407830)	1.000

Repère	Référence	Désignation	Quantité
62	SX5409570	PRISE DE PRESSION FF (5409570)	1.000
624	SX8435380	CAPTEUR DE DEBIT (8435380)	1.000
63	SX8422570	ELECTRODE ALLUMAGE (x4) (8422570)	1.000
634	SX5115960	VOLET ANTIREFOULEUR GAUCHE	1.000
70	SX5688900	TUBE POMPE/ECHANGEUR (5688900)	1.000
70	SX5681020	TUBE POMPE/ECHANGEUR (5681020)	1.000
72	SX5687280	POMPE UP 15-50 AO AV.CONN.2V (5687280)	1.000
73	SX0607290	DEGAZEUR (607290)	1.000
732	SX0620210	RESSORT (0620210)	1.000
74	SX5406360	O-RING 14X1,78 (x3)	1.000
75	SX5404670	JOINT TUBE/CAISSON (x3) (PDM5404670)	1.000
76	SX5686670	ECHANGEUR SANITAIRE 12 PLAQUES (5686670)	1.000
77	SX5404520	JOINT ECHANGEUR SANITAIRE(x4) (PDM5404520)	1.000
8	SX5408080	TUBE SILICONE PRESSOSTAT 4,8X8 L=270 (x4) (5408080)	1.000
80	SX5687120	GROUPE ENTREE SANIT/RET.CHAUF. (5687120)	1.000
81	SX0620340	GROUPE FILTRE (620340)	1.000
87	SX5210710	ELEMENT DE CONNECTION POMPE (5210710)	1.000
9	SX5108700	DIAPHRAGME D:80 (PDM5108700)	1.000
90	SX0611930	ROBINET DE REMPLISSAGE (611930)	1.000
91	SX5652030	ROBINET DE VIDANGE (PDM5652030)	1.000
92	SX9951170	SOUPAPE DE SECURITE 3BARS (9951170)	1.000
98	SX5213880	TUBE BY-PASS CUBE (MAX 16P)(5213880)	1.000
99	SX8380850	CLIP TUBE BY-PASS	1.000
999	SX8414620	CABLE M1 ALIM ELEC (8414620)	1.000
999	SX8512290	CABLE CN2-11 BASSE TENSION	1.000
999	SX8512300	CABLE CN2-11 BASSE TENSION	1.000
999	SX8512310	CABLE CN10/M1-ALIM (8512310)	1.000
999	SX8512270	CABLE CN1/POMP-V3V-VENT (8512270)	1.000
999	SX8414540	CABLE M1/TA (8414540)	1.000
999	SX8419080	CABLE MASSE SIT (8419080)	1.000



INITIA 3 FF

N° 1730

CPN456243091

INITIA 3 2.24 FF

Tab 327

Tab 327

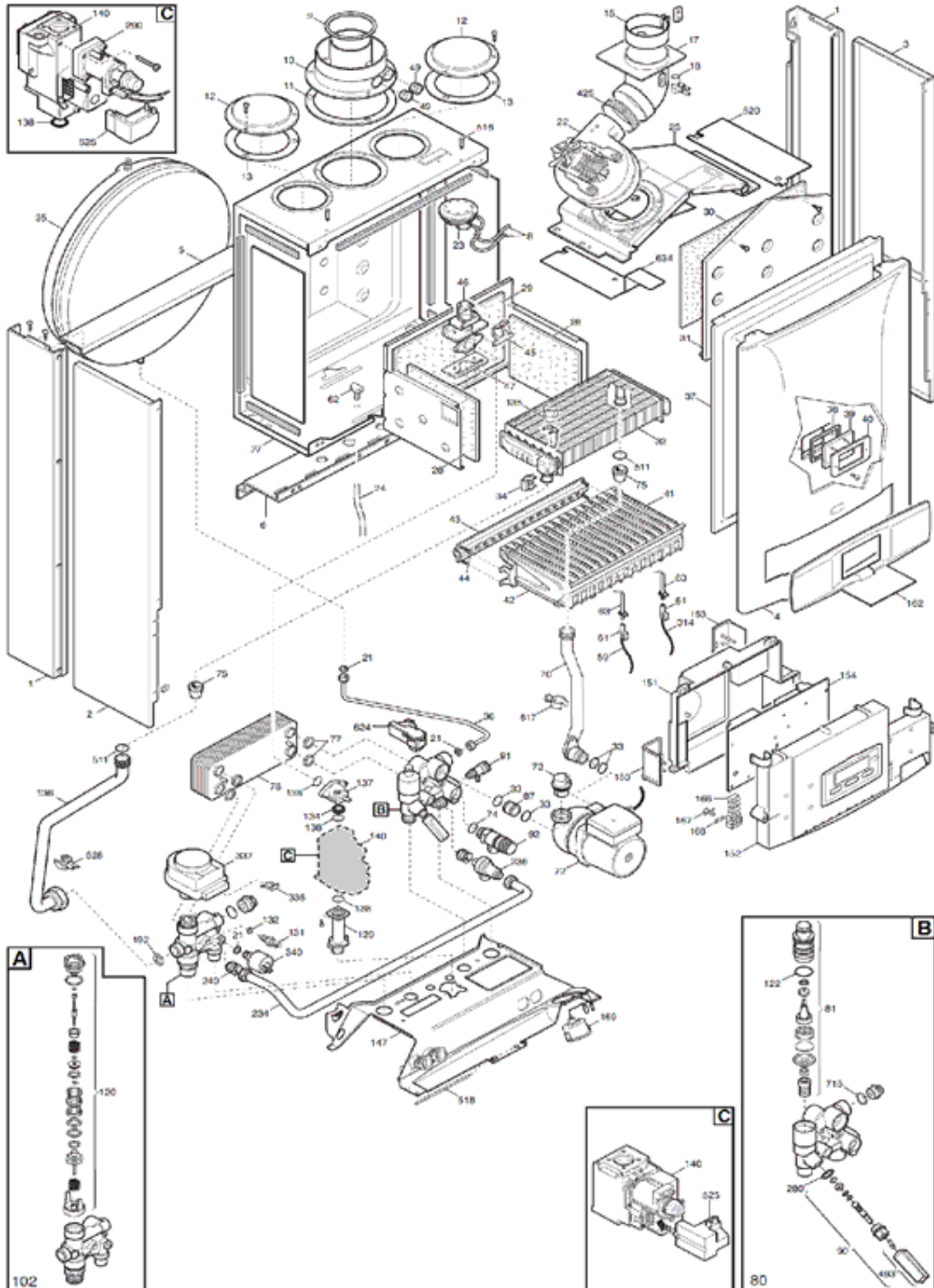

Repère	Référence	Désignation	Quantité
1	SX5683090	MONTANT LATERAL (5683090)	1.000
10	SX5207060	RACCORDEMENT VENTOUSE (5207060)	1.000
102	SX5696040	ENS.VANNE 3 VOIES	1.000
11	SX5407890	JOINT VENTOUSE CAOUTCHOUC (5407890)	1.000
12	SX5108690	OBTURATEUR (5108690)	1.000
120	SX0626710	BOUCHON AVANT(GROUPE)10.0355-	1.000
122	SX5405370	O-RING "FILTRE SANITAIRE" (x3) (5405370)	1.000
13	SX5407400	JOINT OBTURATEUR DECOUPE (x3)	1.000
131	SX8434820	SONDE CTN CH et SN MURALE (8434820)	1.000
132	SX5402830	JOINT SONDE SANITAIRE (X10) (PDM5402830)	1.000
134	SX5214000	DIAPHRAGME GAZ 4,9mm (5214000)	1.000
135	SX9951610	SECURITE DE CHAUFFAGE 105° (9951610)	1.000
136	SX5681010	TUBE DEPART CHAUF/ECHANGEUR (5681010)	1.000
137	SX0610080	TUBE GAZ (610080)	1.000
138	SX5402010	JOINT O-RING (x3) (PDM5402010)	1.000
139	SX5210630	RACCORD ENTREE GAZ ((5210630)	1.000
140	SX5653610	VANNE GAZ SIT (845 SIGMA)	1.000
140	SX5665220	VANNE GAZ HONEYWELL (VK4105M)	1.000
147	SX5680910	TRAVERSE LUNA 3 (5680910)	1.000
15	SX0600530	COLLIER SORTIE EXTRACTEUR (0600530)	1.000
151	SX5412250	COUVERCLE BOITE ELECTRIQUE (5412250)	1.000
152	SX5681340	PANNEAU DE COMMANDE LUNA 3(5681340)	1.000
153	SX5407660	COUVERCLE BRANCHE.ELECTRIQUE (5407660)	1.000
154	SX5687010	CIRCUIT IMPRIME BetP SERIE 3 (5687010)	1.000
162	SX5687380	FACADE TABLEAU BORD INITIA (5687380)	1.000
166	SX8421590	BORNIER DE RACCORDEMENT (PDM8421590)	1.000
167	SX5405340	PORTE-FUSIBLES (x3) (PDM5405340)	1.000
168	SX9950580	FUSIBLES 2A 250V (X10) (9950580)	1.000
169	SX9951650	MANOMETRE AVEC SUPPORT (9951650)	1.000
17	SX5213750	COUDE EVACUATION FUMEES (5213750)	1.000
18	SX5407050	VENTURI (5407050)	1.000
192	SX5404650	JOINT G3/4" 17x24x2 (X10) #	1.000
2	SX5681390	PANNEAU COTE GAUCHE	1.000
21	SX5402050	JOINT 6,1x11,5x1,5 (X3)	1.000
22	SX5653850	EXTRACTEUR 1V MVL RLG108 (5653850)	1.000
22	SX5628080	EXTRACTEUR 2V 55W 220V	1.000
23	SX0618470	PRESSOSTAT 1,2MB HONEYWELL	1.000
234	SX5687180	TUBE DISCONNECTEUR WATTS LUNA3 (5687180)	1.000
236	SX5658650	DISCONNECTEUR WATTS(jjj005658650)	1.000
24	SX5407930	TUBE SILICONE PRISE LG.150 (5407930)	1.000
240	SX0618480	CLAPET AVEC RACCORD ET O RING (0618480)	1.000
25	SX5681090	HOTTE EVACUATION DES FUMEES (5681090)	1.000
27	SX5681180	CHAMBRE ETANCHE (5681180)	1.000
28	SX5213190	PANNEAU ISOLANT LATERAL(5213190)	1.000
280	SX5207730	JOINT 14,2X18X1,5 AL-18 (x3) (5207730)	1.000
29	SX5213290	PANNEAU ISOLANT ARRIERE 32KW (5213290)	1.000
290	SX5665230	VANNE GAZ VK 4105 M (5665230)	1.000
3	SX5681380	PANNEAU COTE DROIT	1.000

Repère	Référence	Désignation	Quantité
30	SX5213340	PANNEAU ISOLANT AVANT (5213340)	1.000
31	SX5111840	PANNEAU AVANT CHAMBRE COMBUSTION (5111840)	1.000
314	SX8418870	CABLE ELECTRODE D'IONISATION (x2) (8418870)	1.000
32	SX5692520	ECHANGEUR ENSEMBLE 25KW GIANN	1.000
32	SX5681190	ECHANGEUR H2O/GAS (5681190)	1.000
33	SX5403130	O-RING 22X3 EPDM (x3) (5403130)	1.000
336	SX8380680	RESSORT FIX MOTEUR V3V	1.000
337	SX5694580	MOTEUR V3V ELBI	1.000
34	SX5113650	CLIPS ECHANGEUR PRINCIPAL	1.000
340	SX9951690	PRESSOSTAT CHAUFFAGE (9951690)	1.000
35	SX5625560	VASE D'EXPANSION 8L(PDM5625560)	1.000
36	SX5653290	TUBE VASE D'EXPANSION (5653290)	1.000
37	SX5653710	PANNEAU AVANT CHAMBRE ETANCHE (5653710)	1.000
38	SX5401610	JOINT HUBLLOT (x3) (5401610)	1.000
39	SX5203930	HUBLLOT (5203930)	1.000
4	SX5116810	PANNEAU AVANT INITIA 3 (5116810)	1.000
40	SX5103360	COUVERCLE HUBLLOT (5103360)	1.000
41	SX5653300	BRULEUR 15 BECS (5653300)	1.000
42	SX5604090	ELEMENT BRULEUR (5604090)	1.000
425	SX5412270	JOINT DE VENTURI (5412270)	1.000
43	SX0606140	NOURRICE PORTE-INJECTEUR 15T.D.1,18 (606140)	1.000
44	SX0608440	KIT INJECTEURS D.1,18 GN (608440)	1.000
44	SX0601520	KIT INJECTEURS D.0,74 BP (601520)	1.000
44	SX5688320	KIT INJECTEURS D.0,74 BP (5688320)	1.000
45	SX5407940	JOINT NOURRICE (x3) (5407940)	1.000
46	SX5657180	RACCORD NOURRICE (5657180)	1.000
47	SX5407810	JOINT NOURRICE/CAISSON (5407810)	1.000
49	SX5207070	BOUCHON RACCORDEMENT VENTOUSE (5207070)	1.000
493	SX0605660	MANETTE ROBINET REMPLISSAGE	1.000
5	SX5110290	TRAVERSE ARRIERE SUPERIEURE (5110290)	1.000
511	SX5404600	O-RING 17,86X2,62 (X3)	1.000
516	SX5210670	PISTON (5210670)	1.000
517	SX5407840	CLIP FIXATION TUBE (5407840)	1.000
518	SX5112040	CHEVILLE PANNEAU COMMANDE (5112040)	1.000
520	SX5112050	VOLET (5112050)	1.000
525	SX8510910	ALLUMEUR VG HONEYWELL	1.000
528	SX8435360	SONDE ITS (8435360)	1.000
59	SX8419050	CABLE ELECTRODE D'ALLUMAGE (x2) (8419050)	1.000
6	SX5109640	TRAVERSE ARRIERE INFERIEURE (5109640)	1.000
600	SX5112530	RESSORT FIXATION DISCONNECTEUR (5112530)	1.000
61	SX5407830	PROTECTION ELECTRODE (x3) (5407830)	1.000
62	SX5409570	PRISE DE PRESSION FF (5409570)	1.000
624	SX8435380	CAPTEUR DE DEBIT (8435380)	1.000
63	SX8422570	ELECTRODE ALLUMAGE (x4) (8422570)	1.000
634	SX5115960	VOLET ANTIREFOULEUR GAUCHE	1.000
70	SX5688900	TUBE POMPE/ECHANGEUR (5688900)	1.000
72	SX5687280	POMPE UP 15-50 AO AV.CONN.2V (5687280)	1.000
73	SX0607290	DEGAZEUR (607290)	1.000

Repère	Référence	Désignation	Quantité
74	SX5406360	O-RING 14X1,78 (x3)	1.000
75	SX5404670	JOINT TUBE/CAISSON (x3) (PDM5404670)	1.000
76	SX5686670	ECHANGEUR SANITAIRE 12 PLAQUES (5686670)	1.000
77	SX5404520	JOINT ECHANGEUR SANITAIRE(x4) (PDM5404520)	1.000
8	SX5408080	TUBE SILICONE PRESSOSTAT 4,8X8 L=270 (x4) (5408080)	1.000
80	SX5696350	GR.ENT.SAN-RET.CHAUFF/ROB-8L	1.000
81	SX0620340	GROUPE FILTRE (620340)	1.000
87	SX5210710	ELEMENT DE CONNECTION POMPE (5210710)	1.000
9	SX5108700	DIAPHRAGME D:80 (PDM5108700)	1.000
90	SX0611930	ROBINET DE REMPLISSAGE (611930)	1.000
91	SX5652030	ROBINET DE VIDANGE (PDM5652030)	1.000
92	SX9951170	SOUPAPE DE SECURITE 3BARS (9951170)	1.000
999	SX8512270	CABLE CN1/POMP-V3V-VENT (8512270)	1.000
999	SX8414540	CABLE M1/TA (8414540)	1.000
999	SX8419080	CABLE MASSE SIT (8419080)	1.000
999	SX8512300	CABLE CN2-11 BASSE TENSION	1.000
999	SX8512310	CABLE CN10/M1-ALIM (8512310)	1.000
999	SX8512290	CABLE CN2-11 BASSE TENSION	1.000
999	SX8414620	CABLE M1 ALIM ELEC (8414620)	1.000