

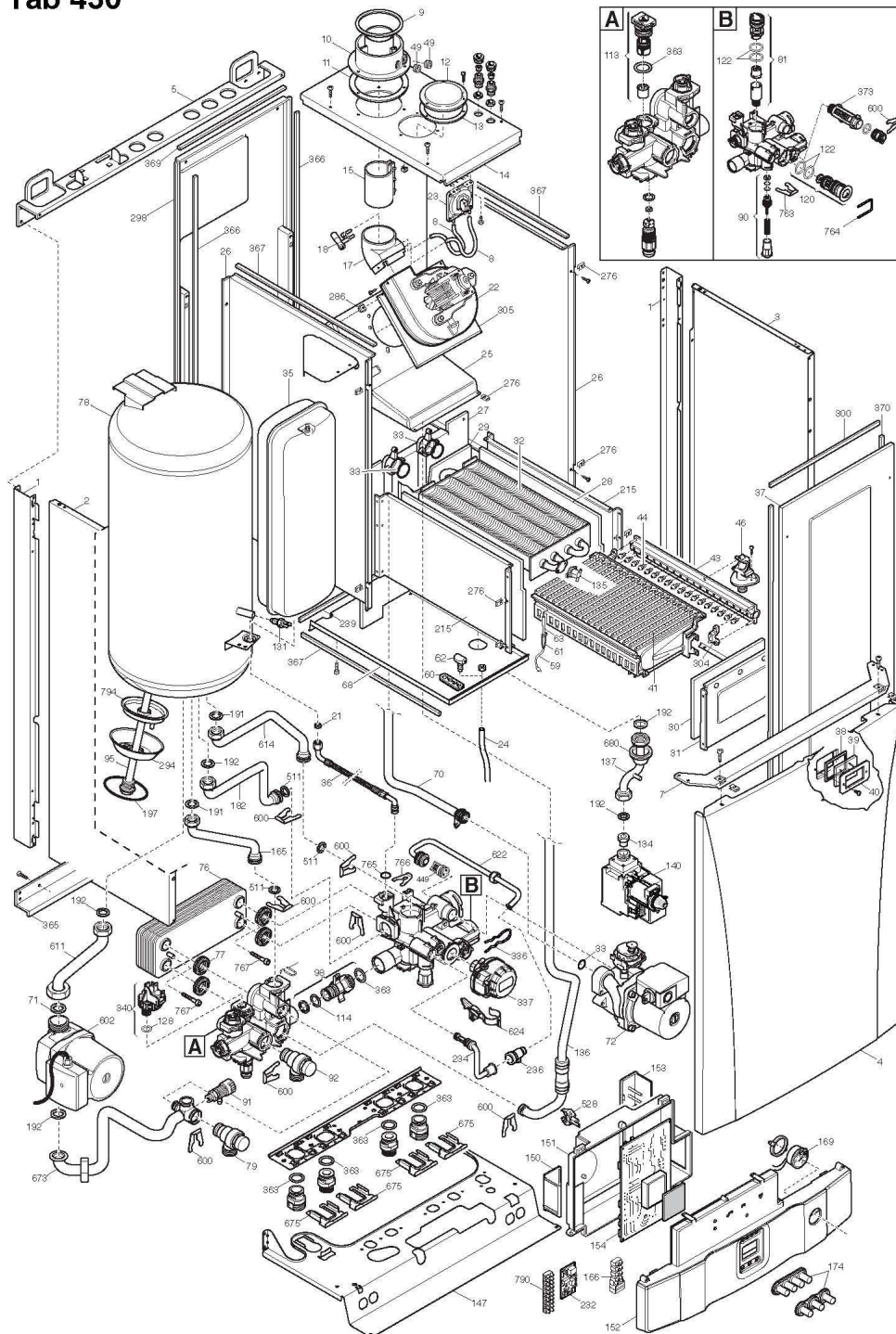

Tab 430



MS 24 BIC FF

Réf.	Référence	Description	Qté	Tarif	Substitué	Tarif Sub.	Remarques
0	JJD710589700	BLOC HYDRAULIQUE MS BIC	1	352,00 €			
0	JJD710400700	FAISCEAU MISE A LA MASSE	1	2,25 €			
0	JJD710501600	FAISCEAU RALLONGE SONDE DHV	1	9,94 €			
0	JJD710542800	FAISC.24V SONDES ECS-CAPTEUF	1	15,20 €			
0	JJD710542900	FAISCEAU 230V VG-MOTEUR V3V-C	1	39,20 €			
0	JJD710399800	FAISCEAU SONDES FF	1	12,60 €			
0	JJD710399900	FAISCEAU VENTILATEUR	1	11,20 €			
0	JJD710296200	DOUILLE LAITON 20,7/14x27	1	9,83 €			
0	710048000	EPINGLE TUBE DISCO U D.2MM	1	1,25 €			
0	7617701	KIT JOINTS ZENA	1	78,80 €			
0	710139500	PURGEUR CIRCULATEUR WILO	1				
0	JJD710047000	BOUCHON + JOINT TUBE SORTIE E	1	4,48 €			
0	JJD710046700	RESSORT PLAT D.12mm	1	1,25 €			
0	710493600	PURGEUR CIRCULATEUR GRUNDF	1	30,20 €			
0	JJD005408270	JOINT TORIQUE D.11,91X2,62 EPDM	1	1,25 €			
0	711230600	JOINT TORIQUE 17.13X2.62 EP 70 (1	2,90 €			
0	7768020	RACCORD G3/4 + O-RING	1	17,00 €			
0	7100460	STG RACCORD G1/2+O-RING	1	15,00 €			
1	JJD005116480	CHASSIS MONTANT VERTICAL	1	9,61 €			
2	JJD000620790	PANNEAU LATERAL GAUCHE	1	35,00 €			
3	JJD000620810	PANNEAU LATERAL DROIT	1	35,00 €			
4	JJD005116730	PANNEAU AVANT	1	58,40 €			
5	JJD005109740	TRAVERSE ARRIERE SUPERIEURE	1	8,41 €			
7	JJD005107950	TRAVERSE AVANT SUPERIEURE	1	3,28 €			
8	JJD005402270	TUBE SILICONE PRESSOSTAT LG.(1				
9	JJD000625420	REDUCT.ASPIRATION-DIAPHR D.7	1	3,06 €			
10	JJD005207060	BRIDE DE RACCORDEMENT	1	14,70 €			
11	JJD005407890	JOINT BRIDE DE RACCORDEMENT	1	1,48 €			
12	JJD005108690	OBTURATEUR	1	1,25 €			
13	JJD005407400	JOINT OBTURATEUR CAOUTCHOU	1	1,25 €			
14	JJD005658850	PANNEAU SUPERIEUR CAISSON	1	39,60 €			
15	JJD005645800	JOINT SORTIE VENTILATEUR	1	9,94 €			
17	JJD000600490	COUDE 45°	1	11,90 €			
18	JJD005407050	VENTURI	1	1,86 €			
21	JJD005402050	JOINT VASE/DISCONNECTEUR 6,1)	1				
22	JJD005632530	VENTILATEUR 1V 61W 230V	1	88,80 €			
23	JJD000628660	PRESSOSTAT 115-95Pa HUBA	1				
23	JJD000628640	PRESSOSTAT HONEYWELL 1,2mbar	1				
24	JJD005402490	TUBE SILICONE 4,5X8 LG.300 AR	1	1,36 €			
25	JJD005634580	ANTIREFOULEUR	1	29,50 €			
26	JJD005107440	PANNEAU LATERAL CAISSON	1	23,10 €			
27	JJD005106560	PANNEAU ARRIERE CAISSON	1	4,26 €			
28	JJD005213170	ISOLATION LATERALE CAISSON	1	9,83 €			
29	JJD005213250	ISOLATION ARRIERE CAISSON	1	4,92 €			
30	JJD005213410	ISOLATION AVANT CAISSON	1	4,59 €			
31	JJD005108420	PANNEAU AVANT FOYER	1	5,30 €			
32	JJD005646410	ECHANGEUR CHAUFFAGE	1	421,00 €			
33	JJD005403130	JOINT TORIQUE 22X3 EPDM	1				
35	JJD005629130	VASE EXPANSION 7.5L	1	69,70 €			

MS 24 BIC FF

36	JJD710605000 TUBE VASE D'EXPANSION	1	9,73 €	
37	JJD005621590 PANNEAU AVANT CAISSON	1		
38	JJD005401610 JOINT VOYANT FF	1	1,25 €	
39	JJD005203930 VOYANT FF	1	2,35 €	
40	JJD005115590 BRIDE VOYANT	1	1,25 €	
41	JJD005630310 BRULEUR 18 BECS	1	58,10 €	
43	JJD005633950 RAMPE INJECTEUR D.1,18	1	32,30 €	
44	JJD005209150 INJECTEUR D.1,18	1	1,25 €	
46	JJD000607990 RACCORD NOURRICE	1	11,80 €	
49	JJD005207070 BOUCHON PRISE DE MESURE	1	1,81 €	
59	JJD710400100 CABLE D'ALLUMAGE	1	3,94 €	
60	JJD005408280 JOINT ELECTRODE D'ALLUMAGE	1	1,42 €	
61	JJD005404920 PROTECTION ELECTRODE	1		
62	JJD005409570 RACCORD TUBE COMPENSATEUR	1	1,25 €	
63	JJD008422570 ELECTRODE ALLUMAGE + IONISAT	1	3,06 €	
68	JJD000618970 PLAQUE INFERIEURE FOYER	1	Nous consulter ...	
70	JJD710294200 TUBE POMPE - ECHANGEUR	1	43,90 €	
71	JJD005405000 JOINT G1 22X30,3X2-WRC	1	1,25 €	
72	JJD710396300 CIRCULATEUR 2 VITESSES	1		
76	JJD005689930 ECHANGEUR A PLAQUES (20 PLAC	1	104,00 €	
77	JJD005404520 JOINT ECHANGEUR A PLAQUES	1	1,25 €	
78	JJD710610500 BALLON ISOLE	1	846,00 €	
79	JJD710619400 SOUPAPE DE SECURITE 7 BAR NO	1	20,50 €	
81	JJD710735900 ENS.FILTRE ECS+TURB.+LIMIT.DEI	1	28,10 €	
90	JJD710046600 ROBINET DE REMPLISSAGE	1		
91	JJD005652030 ROBINET DE VIDANGE	1	5,19 €	
92	JJD710071200 SOUPAPE DE SECURITE 3 BAR MI	1	9,51 €	
95	JJD005679910 ANODE MAGNESIUM	1	28,30 €	
98	JJD710046300 TUBE BY-PASS MI	1	8,41 €	
113	JJD710048300 CLAPET ANTI-RETOUR BY-PASS M	1	9,73 €	
114	JJD710046400 JOINT TORIQUE D.15,54X2,62	1	1,25 €	
120	JJD710144100 CARTOUCHE VANNE 3 VOIES	1	35,40 €	
122	JJD710047800 JOINT TORIQUE D.23,47X2,62	1	1,25 €	
128	JJD710048800 JOINT TORIQUE D.8,9X1,9	1	1,25 €	
131	JJD008435400 SONDE NTC	1	34,40 €	
134	JJD009952190 DIAPHRAGME GAZ 4,2mm	1	1,54 €	
135	JJD009950760 THERMOSTAT DE SECURITE	1	4,59 €	
136	JJD710294300 TUBE VANNE 3 VOIES/ECHANGEUR	1	61,70 €	
137	JJD005658790 TUBE GAZ	1	20,50 €	
140	JJD005658830 VANNE GAZ (SIT SIGMA 845063)	1	108,00 €	
147	JJD710299500 TRAVERSE PLATINE HYDRAULIQU	1	23,80 €	
150	JJD005412180 COUVERCLE	1	1,42 €	
151	JJD005412250 COUVERCLE BOITE ELECTRIQUE	1	7,11 €	
152	JJD710408700 PANNEAU DE COMMANDE MS BIC	1	35,50 €	
153	JJD005407660 COUVERCLE ARRIERE TABLEAU	1	1,25 €	
154	JJD710688600 CARTE ELECTRONIQUE	1		
165	JJD710605800 TUBE SORTIE BALLON	1	14,40 €	
166	JJD005688430 BARRETTE CONNEXION 5 POLES	1	5,19 €	
169	JJD005700610 MANOMETRE D.40 AVEC SUPPORT	1	15,20 €	
174	JJD000628840 CLAVIER ELASTOMERE 3 ET 4 BOL	1	4,37 €	

MS 24 BIC FF

182	JJD710605700 TUBE SORTIE ECS - RECIRCULATI	1	17,70 €
191	JJD005408970 JOINT G1/2"	1	1,25 €
192	JJD005404650 JOINT G3/4-17X24X2	1	
197	JJD005412820 JOINT 85,09X5,34 EPDM	1	8,19 €
215	JJD005106570 PANNEAU LATERAL FOYER	1	5,68 €
232	JJD005689820 CARTE RELAIS	1	32,40 €
234	JJD710395200 TUBE DISCONNECTEUR MI	1	39,40 €
236	JJD710877800 DISCONNECTEUR+JTS+TUBES MS	1	97,70 €
239	JJD005404380 JOINT LG.250mm	1	1,25 €
276	JJD001340440 CLIP	1	1,25 €
286	JJD008240530 ECROU M5	1	1,25 €
294	JJD005115820 COUVERCLE INFERIEUR	1	50,70 €
298	JJD005701260 PANNEAU ARRIERE CAISSON	1	45,50 €
300	JJD005404420 JOINT LG.235mm	1	1,25 €
304	JJD005208400 SUPPORT NOURRICE	1	3,61 €
305	JJD005107430 PLAQUE VENTILATEUR	1	2,74 €
336	JJD710047400 CLIP FIXATION MOTEUR VANNE 3 \	1	1,69 €
337	JJD710047300 MOTEUR VANNE 3 VOIES MI	1	23,20 €
340	JJD710048500 PRESSOSTAT MANQUE EAU MI	1	25,50 €
363	JJD710045300 JOINT TORIQUE D.17,96X2,62	1	1,25 €
365	JJD005106530 TRAVERSE ARRIERE INFERIEURE	1	5,30 €
366	JJD005404370 JOINT LG.665mm	1	2,74 €
367	JJD005404390 JOINT LG.430mm	1	1,86 €
369	JJD005404400 JOINT LG.205mm	1	1,25 €
370	JJD005404410 JOINT LG.658mm	1	2,35 €
373	JJD710047100 FILTRE CHAUFFAGE	1	2,35 €
449	JJD005640030 CLAPET ANTI-RETOUR DISCONNEI	1	7,97 €
511	JJD005404600 JOINT TORIQUE D.17,86X2,62 EPDM	1	
528	JJD008435500 SONDE DEPART CHAUFFAGE	1	5,30 €
600	JJD710045400 CLIP PLAT D.18MM SOUPAPE	1	1,25 €
602	JJD710296700 CIRCULATEUR GRUNDFOS UPS01!	1	236,00 €
611	JJD710605500 TUBE ENTREE SANITAIRE - RECIR	1	16,20 €
614	JJD710605600 TUBE ENTREE BALLON	1	16,20 €
622	JJD710395300 TUBE DISCONNECTEUR	1	21,70 €
624	JJD710046200 CAPTEUR EFFET HALL	1	15,30 €
673	JJD710296900 TUBE SORTIE ECS CIRCUIT BALLO	1	44,10 €
675	JJD710046100 DOUBLE VERROUIL.RESSORT PLA	1	2,35 €
680	JJD005409250 JOINT PASSE-TUBE D.15	1	1,54 €
763	JJD710046700 RESSORT PLAT D.12mm	1	1,25 €
764	JJD710047500 EPINGLE EN U D.3mm	1	1,69 €
765	JJD710069700 JOINT TORIQUE D.9,19X2,62 EPDM	1	1,25 €
766	JJD005118110 RESSORT PLAT D.10mm	1	1,25 €
767	JJD710046900 VIS ECHANGEUR A PLAQUES	1	1,25 €
790	JJD710117900 BARRETTE CONNEXION ELECTRIC	1	2,74 €
794	JJD005115810 COUVERCLE SUP. AV/TROU INSPE	1	71,70 €

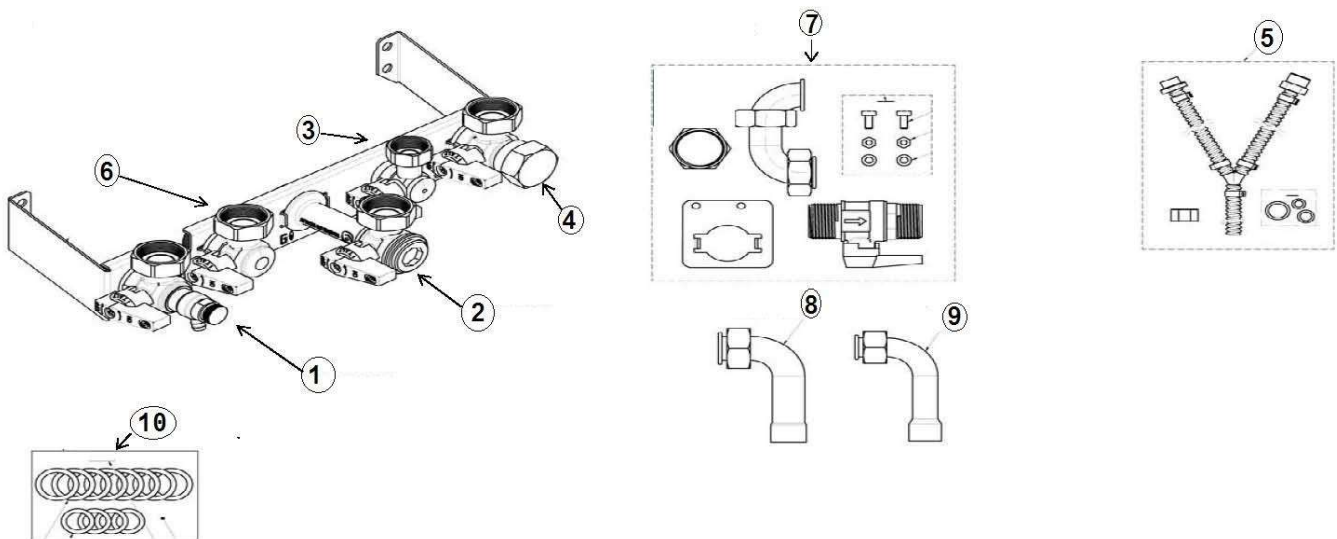

MS 24 BIC FF

Réf.	Référence	Description	Qté	Tarif	Substitut	Tarif Sub.	Remarques
1	JJD710451800	ROBINET DEPART CHAUFFAGE	1	23,70 €			
2	JJD710373200	ROBINET GAZ	1				
3	JJD710227300	ROBINET ENTREE SANITAIRE G1/2	1	14,00 €			
4	JJD710399700	ROBINET CHAUFFAGE/BALLON	1	25,30 €			
5	JJD710467500	TUYAU EVACUATION CONDENSAT	1	22,40 €			
6	JJD710071900	ROBINET RETOUR CHAUFFAGE	1	18,00 €			
7	JJD710668900	ROBINET EXTERIEUR	1	27,00 €			
8	JJD710400000	TUBE D.18mm	1	6,12 €			
9	JJD710400200	TUBE D.14mm	1	4,92 €			
10	JJD003630590	KIT JOINTS	1	1,98 €			

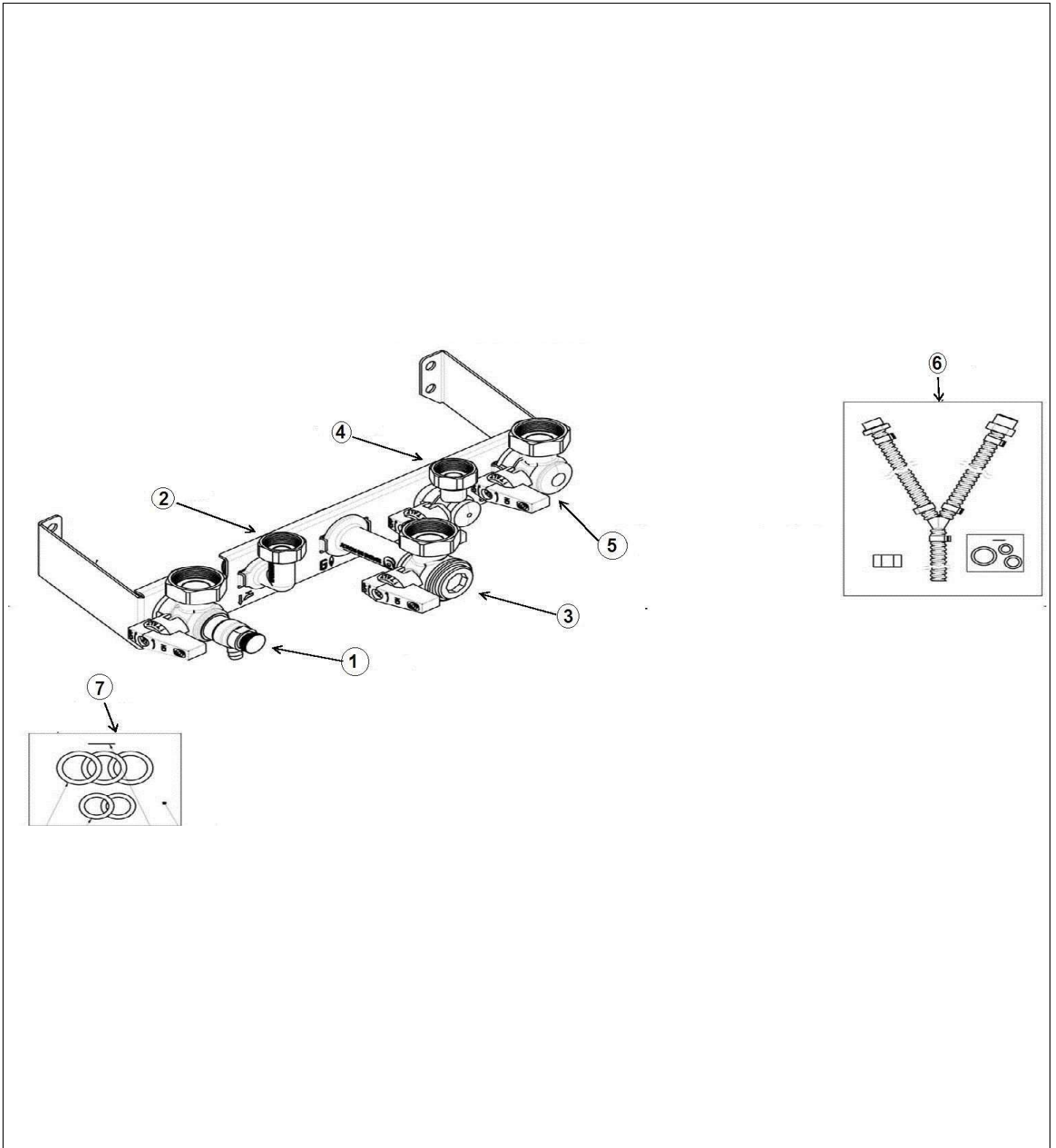

MS 24 BIC FF

Réf.	Référence	Description	Qté	Tarif	Substitut	Tarif Sub.	Remarques
0	JJJ005210220	BOUCHON 3/4"	1	6,23 €			
1	JJD710451800	ROBINET DEPART CHAUFFAGE	1	23,70 €			
2	JJD710072000	COUDE DEPART ECS	1	6,77 €			
3	JJD710373200	ROBINET GAZ	1				
4	JJD710227300	ROBINET ENTREE SANITAIRE G1/2	1	14,00 €			
5	JJD710071900	ROBINET RETOUR CHAUFFAGE	1	18,00 €			
6	JJD710467500	TUYAU EVACUATION CONDENSAT	1	22,40 €			
7	JJD710355400	KIT JOINTS	1	1,25 €			

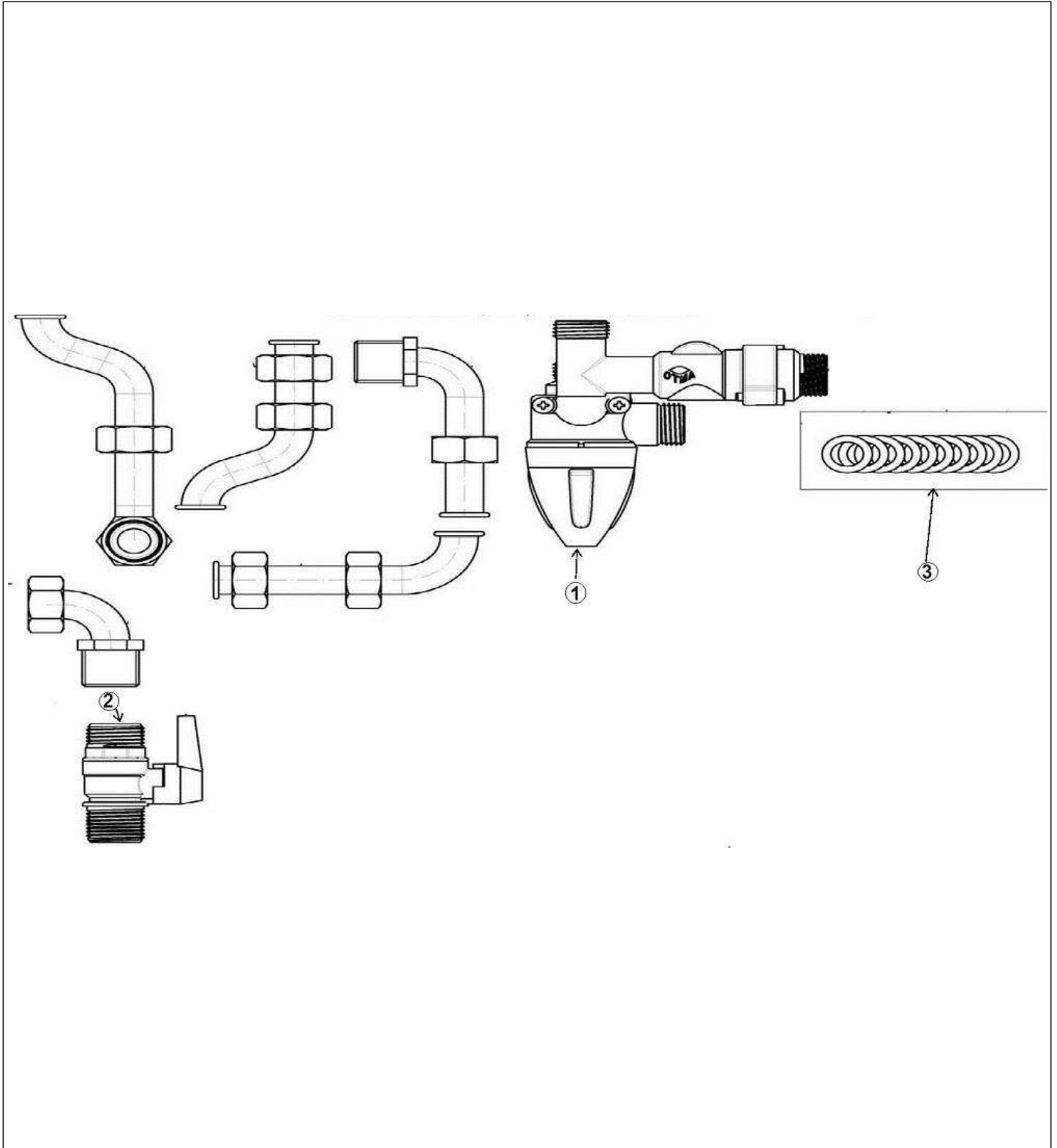

MS 24 BIC FF

Réf.	Référence	Description	Qté	Tarif	Substitut	Tarif Sub.	Remarques
1	JJD005699550	VALVE MITIGEUR	1	201,00 €			
2	JJD003623250	ROBINET G1/2"	1	15,30 €			
3	JJD003628630	KIT JOINTS	1	1,42 €			

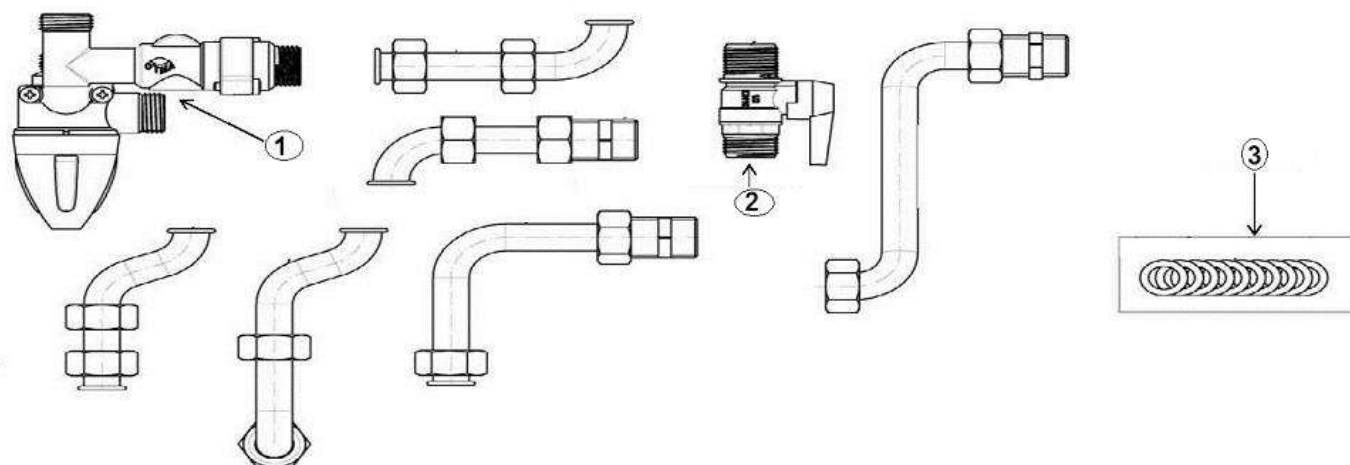

MS 24 BIC FF

Réf.	Référence	Description	Qté	Tarif	Substitut	Tarif Sub.	Remarques
1	JJD005699550	VALVE MITIGEUR	1	201,00 €			
2	JJD003623250	ROBINET G1/2"	1	15,30 €			
3	JJD003628630	KIT JOINTS	1	1,42 €			

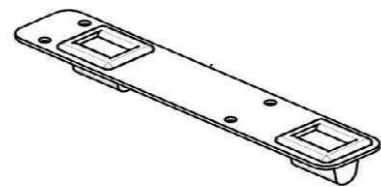
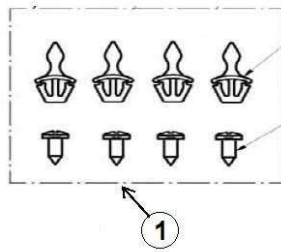
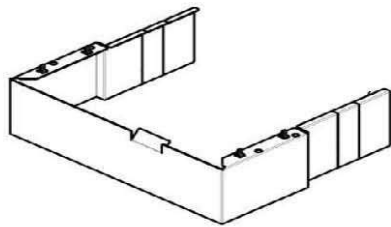

Tab 5

MS 24 BIC FF

Réf.	Référence	Description	Qté	Tarif	Substitut	Tarif Sub.	Remarques
1	JJD710553600	KIT CLIPS	1	1,54 €			